



CA-RM ES SERIES





VORTICE S.p.A. is now part of a multinational group, **the VORTICE GROUP**, which operates through its own companies or local distributors in over 90 countries worldwide and has a rich product portfolio that guarantees air quality and climate comfort. The headquarters of VORTICE S.p.A are in Tribiano (Milan).



The VORTICE GROUP also includes:

[1]
VORTICE LIMITED, the UK subsidiary of VORTICE S.p.A founded in 1977 with headquarters in Burton upon Trent.

[2]
VORTICE INDUSTRIAL, born from the acquisition in 2010 of Loran srl, based in Isola della Scala (VR).

[3]
VORTICE Ventilation System, a company inaugurated in 2013 with headquarters in Changzhou, China.

[4]
VORTICE Latam, based in Alajuela in Costa Rica, established in 2012.

[5]
CASALS VENTILACIÓN AIR INDUSTRIAL S.L., a historic Spanish brand, based in Sant Joan de les Abadesses, Girona, was acquired in 2019.



WHAT RADON IS AND WHAT THE HEALTH RISKS ARE

Radon is a radioactive gas derived from the decay of uranium, naturally present in the soil and in rocks.

WHERE IT IS:

The main source of this gas is the soil (other sources can be building materials, especially if of volcanic origin such as tuff or granite and water) from which it leaks accumulating in closed rooms where it becomes dangerous.

HEALTH RISKS:

Once it has accumulated, Radon can be breathed and continue radioactive decay within the body. Epidemiological studies by the WHO and the AIRC have scientifically established its carcinogenicity, classifying it as the second cause of lung cancer in the world after tobacco smoke.



Regulatory Standards Directives and regulations

Electrical Safety Standard:

- EN 60335-1
- EN 60335-2-80
- EN 60529
- EN 62233

Standards for Electromagnetic Compatibility

- EN 55014-1
- EN 55014-2
- EN 61000-3-2
- EN 61000-3-3

European directives and regulations for CE marking

- Machinery Directive (2006/42/EC)
- Low Voltage Directive
- Electromagnetic Compatibility Directive (2004/108 / EC)
- ECODESIGN 2009/125 / EC Design Directive
- Erp Regulation N ° 327/2011 / EU (relating to fans)
- Erp Regulation 1253/2014 (relating to ventilation units)

WHAT TO DO TO HAVE A HEALTHY RADON- PROOF BUILDING AND PROTECT YOUR HEALTH?

01

Radon tends to accumulate in closed environments, especially underground ones or in any case in direct contact with the ground.

02

The most commonly used techniques are aimed at hindering its escape from the subsoil. Usually, this occurs through the passage of a sheath in gas-impermeable material, in correspondence with the foundations of the building, so as to prevent the entry of gas, or through the construction of a ventilated crawl space or by creating a ventilation system capable of sucking the radon from the underground rooms where it collects, to disperse it outside.

03

Due to its high volatility and chemical inertia, Radon hardly reacts with other elements, and actually tends to rise to the surface and be dispersed.

04

The fans of the CA-RM ES and CA-RM RF ES series can be installed indoor (in case of non-invasive interventions) or in extraction ducts outside the building, also exploiting the presence of underground wells the IP47 high protection of the CA-RM ES models ensures perfect watertight integrity and correct operation even in the event of flooding, or at the end of vertical ventilation ducts that operate on several floors. (CA-RM RF ES). In all cases, the optimal sealing of the casings and couplings to the extraction and delivery pipes ensures that there is no risk of harmful fumes.

05

The complete electronic suite supplied with it allows the constant monitoring of the correct functioning of the system, the programming of specific intervention logics and promptly signals the occurrence of any problems.



FACTORS THAT AFFECT THE PRESENCE OF RADON

In addition to the geographical area, the presence of Radon in buildings depends on:

01

Type of soil

On which the building stands. Radon is more common in areas with a strong presence of lava rocks or in permeable soils.

02

Microclimatic parameters

Which affect air circulation. In fact, in open places Radon is "diluted" by air currents, resulting in little danger to health, in confined places it tends to concentrate, easily reaching harmful concentrations.

03

Building techniques

Radon is sometimes emitted by very common building materials, mainly volcanic tuff; it penetrates through cracks in floors in basements and cellars, through joints and systems and is trapped by the presence of walls and fixtures with high insulation.

How Radon concentration is measured and new legislation

The concentration of Radon is measured in becquerel per unit of volume [Bq /m³], where the becquerel represents the activity of a radionuclide (its radioactivity), which has 1 decay per second (1 Bq is equivalent to 1 disintegration per second).

The recent approval of law 101/2020, in force since the 27th of August, which transposes the European Directive Euratom 2013/59/EU, makes the topic finally relevant also in our country.

The law, establishing safety standards aimed at protecting people from the dangers deriving from ionising radiations, sets new, stricter limits on the average annual concentration of radon activity in the air, as summarised below:

- 300 Bq/m³ for existing homes
- 200 Bq/m³ for homes built after the 31st of December 2024
- 300 Bq/m³ for the workplace

These new limits, more stringent than those previously in force (500 Bq/m³), are combined with the obligation of mitigation in the presence of concentrations exceeding the legal limits and, only if such interventions are insufficient to fall within the limits of the law, there is the possibility of acting on the maximum length of stay allowed in the premises.

The new law also imposes the obligation to measure the concentration of Radon during renovations aimed at energy efficiency. Overall, it is believed that all of this will quickly lead to the demand for ventilation devices capable of ensuring full compliance with the new legislation.

RADON IN ITALY

(BY WAY OF EXAMPLE)

Concentrations of RADON in buildings differ to a large extent, based on the geographical area: Lombardy and Lazio are among the regions with the highest values. There is also a mapping of radon pollution of the various Italian areas.



The Radon National Archive (ANR) contains the data resulting from Radon concentration measurements in over 50 thousand buildings divided between homes, schools and workplaces, carried out as part of measurement surveys organised by regional and national public bodies.



	National Campaign	Regional/Provincial Campaigns
Region/Autonomous Province	Arithmetic average (Bq/m ³)	Arithmetic average (Bq/m ³)
Piedmont	69	70
Aosta Valley	44	83
Lombardy	111	124
Bolzano	70	227 (1)
Trento	49	128 - 131 (2)
Veneto	58	94
Friuli Venezia Giulia	99	162 (3)
Liguria	38	N.D.
Emilia Romagna	44	49 (1)
Tuscany	48	35
Umbria	58	N.D.
Marche	29	N.D.
Lazio	119	121
Abruzzo	60	58
Molise	43	N.D.
Campania	95	N.D.
Apulia	52	N.D.
Basilicata	30	N.D.
Calabria	25	76 (4)
Sicily	35	75 (5)
Sardinia	64	N.D.

(1) winter only values

(2) housing and schools

(3) calculating the average of the rank of the 2005-6 campaign

(4) only for the provinces of Catanzaro and Crotona

(5) only for the province of Ragusa

TECHNICAL CHARACTERISTICS

Available models

- 8 models: in duct version (CA-RM ES) and roof version (CA- RM RF ES).

Casing

- Enclosures in epoxy powder coated steel sheet, glued with water and light resistant epoxy resins, to guarantee a perfect seal over time. The high seal (IP45 or IP47, depending on the range),, prevents the risk of radioactive gas leaks when installing fans in rooms closed (e.g. cellars, warehouses etc ...) as well as ensuring the reliable operation of the products even if exposed to the elements or immersed in submerged wells

Engine holder

- In galvanised steel sheet integrating flow rectifiers, with optimised geometry to maximise the performance of the fans, reducing pressure drops and noise emissions caused by the onset of turbulence.

Motors

- Low consumption, electronically controlled motors (EC brushless), the same technology used by the most modern electric cars, speed-adjustable with 0-10 V signal and virtually maintenance-free.

Centrifugal fans

- Centrifugal fans consisting of backward-curved centrifugal impellers, designed to guarantee high pressures with low consumption and thus favour the continuous operation of the products.

Remote control panel (optional)

Remote control panel with wired connection and LCD display, designed for wall installation and equipped with an access door with lock, to prevent inappropriate alterations to the system settings.

The device allows to:

- Autonomously set the delivered performance up to 2 fans at installation.
- Control its power supply
- Monitor the smooth operation of the fans.
- Control the regular flow of extracted air. In the presence of a flow switch (supplied as an option).
- Program, the operation of the connected fans on an hourly basis and weekly scale.
- Signal, any system malfunctions by means of an acoustic warning and display of error codes.
- The device is also designed for connection to external alarm sirens.

CA-RM RF ES



CA-RM ES



ADVANTAGES FOR THE USER

01

Mitigating the negative effects of Radon on health and ensuring living comfort.

02

High performance (up to 1210 m³/h, 1000 m³/h @ 200 Pa of residual pressure) perfectly suited to the specific application.

03

Reduced consumption - from 90 to 165W, depending on the model - suitable for continuous use, thanks to the electronically controlled motors (EC, brushless), which guarantee a wide adjustment range by means of a normal potentiometer or using the control unit (optional), so as to adapt the delivered performance to the actual mitigation needs of the radon present in the environments involved, optimising consumption and noise emissions.

04

Constancy of the correct effect over time; unlike other solutions such as insulating sheaths which may vary their effectiveness over the years, losing flexibility and thus becoming subject to cracking as a result of the possible settling of the building or the ground on which it rests, a properly designed and monitored ventilation system guarantees the constancy of motivating effectiveness.

05

Guarantee of effective operation over time. The presence, in the SICURBOX control unit (offered as an option), of the integrated diagnostics, which signals any system malfunctions (e.g. stopping the fans), avoids the risk of the indispensable mitigation action of radon concentrations being lost.

ADVANTAGES FOR THE INSTALLER

01

Ease of installation (thanks to the optional pit, already prepared for housing the duct models) and setting, thanks to the control unit (optional) designed for remote installation in an easily accessible room, which allows the initial adjustment of the service provided and the weekly programming of the operating mode of the slave products (useful, for example in the case of rooms that are periodically unoccupied, to optimise energy consumption).

02

Great sturdiness, ensured by the construction entirely in steel sheet and by the EC motors, of the external rotor type and with ball bearing shafts, which guarantee virtually "maintenance free" operation.

03

Great installation flexibility, ensured by the numerous models available, in duct and roof versions, which offer a wide range of flow rates to meet different application needs, and by the complete range of accessories. The possibility of combining two devices, mounted in series, adjustable independently from each other and controlled by the same control unit, further increases the range of possible applications, offering the necessary pressure surplus in the case of systems characterised by high pressure drops.

04

High water tightness: IP45 for the roof version, IPX7 (watertight immersion) certified by a third party, for the duct models; this feature makes them suitable for installation in underground wells exposed to flooding risks.

THE RANGE

Available models

3 MODELS, IN ROOF VERSION

CA-RM 150 RF ES Code 16257
CA-RM 160 RF ES Code 16258
CA-RM 200 RF ES Code 16259

DEGREE OF PROTECTION IP45



10

5 MODELS, IN DUCT VERSION

CA-RM 100 ES Code 16277
CA-RM 125 ES Code 16278
CA-RM 150 ES Code 16279
CA-RM 160 ES Code 16280
CA-RM 200 ES Code 16281

DEGREE OF PROTECTION IP47





Technical data

PRODUCTS	CODE	V~50/60 HZ	W max	A max	RPM	MAX FLOW RATE		MAX PRESSURE		Lp db(A) 3m	°C*** MAX	KG
						m³/h max	l/s max	mmH₂O max	Pa max			
CA-RM 100 ES	16277	220-240	(10V) 90 (8V) 85 (6V) 33 (4V) 11	(10V) 0.75 (8V) 0.70 (6V) 0.30 (4V) 0.12	(10V) 3335 (8V) 3190 (6V) 2450 (4V) 1670	(10V) 350 (8V) 330 (6V) 250 (4V) 150	(10V) 97 (8V) 92 (6V) 69 (4V) 42	(10V) 60 (8V) 57 (6V) 29 (4V) 11	(10V) 589 (8V) 559 (6V) 285 (4V) 108	(10V) 42.6 (8V) 40.5 (6V) 32.8 (4V) 23.7	50	3.5
CA-RM 125 ES	16278	220-240	(10V) 90 (8V) 85 (6V) 35 (4V) 15	(10V) 0.75 (8V) 0.70 (6V) 0.35 (4V) 0.15	(10V) 3280 (8V) 3210 (6V) 2480 (4V) 1750	(10V) 500 (8V) 490 (6V) 340 (4V) 215	(10V) 139 (8V) 136 (6V) 94 (4V) 60	(10V) 57.2 (8V) 55 (6V) 28 (4V) 10	(10V) 564 (8V) 539 (6V) 274 (4V) 98	(10V) 42.4 (8V) 40.5 (6V) 33.2 (4V) 23.7	50	3.5
CA-RM 150 ES	16279	220-240	(10V) 160 (8V) 120 (6V) 55 (4V) 21	(10V) 1.25 (8V) 0.95 (6V) 0.45 (4V) 0.18	(10V) 3365 (8V) 3060 (6V) 2340 (4V) 1620	(10V) 940 (8V) 855 (6V) 600 (4V) 455	(10V) 261 (8V) 238 (6V) 167 (4V) 126	(10V) 92 (8V) 63 (6V) 36 (4V) 17	(10V) 902 (8V) 618 (6V) 353 (4V) 167	(10V) 47.4 (8V) 45.5 (6V) 38.8 (4V) 29.1	50	5.3
CA-RM 160 ES	16280	220-240	(10V) 160 (8V) 120 (6V) 55 (4V) 21	(10V) 1.25 (8V) 0.95 (6V) 0.45 (4V) 0.18	(10V) 3280 (8V) 2980 (6V) 2265 (4V) 1560	(10V) 1080 (8V) 975 (6V) 740 (4V) 500	(10V) 300 (8V) 271 (6V) 206 (4V) 139	(10V) 94 (8V) 62 (6V) 35 (4V) 17	(10V) 922 (8V) 608 (6V) 343 (4V) 167	(10V) 66.4 (8V) 63.6 (6V) 57 (4V) 47.4	50	5.3
CA-RM 200 ES	16281	220-240	(10V) 165 (8V) 130 (6V) 60 (4V) 24	(10V) 1.30 (8V) 1 (6V) 0.50 (4V) 0.20	(10V) 3380 (8V) 3150 (6V) 2430 (4V) 1660	(10V) 1210 (8V) 1135 (6V) 885 (4V) 590	(10V) 336 (8V) 315 (6V) 246 (4V) 164	(10V) 105 (8V) 73 (6V) 43 (4V) 19	(10V) 1030 (8V) 716 (6V) 422 (4V) 186	(10V) 44.6 (8V) 42.7 (6V) 37.8 (4V) 28.5	50	5.7
CA-RM 150 RF ES	16257	220-240	(10V) 160 (8V) 130 (6V) 60 (4V) 24	(10V) 1.20 (8V) 0.95 (6V) 0.49 (4V) 0.22	(10V) 3300 (8V) 3085 (6V) 2360 (4V) 1625	(10V) 775 (8V) 715 (6V) 560 (4V) 380	(10V) 215 (8V) 199 (6V) 156 (4V) 106	(10V) 94 (8V) 65 (6V) 38 (4V) 17	(10V) 922 (8V) 637 (6V) 373 (4V) 164	(10V) 58.9 (8V) 57.8 (6V) 41 (4V) 38.8	50	8
CA-RM 160 RF ES	16258	220-240	(10V) 160 (8V) 140 (6V) 65 (4V) 24	(10V) 1.20 (8V) 1 (6V) 0.55 (4V) 0.22	(10V) 3220 (8V) 3080 (6V) 2405 (4V) 1650	(10V) 840 (8V) 800 (6V) 630 (4V) 425	(10V) 233 (8V) 222 (6V) 175 (4V) 118	(10V) 103 (8V) 69 (6V) 40 (4V) 18	(10V) 1010 (8V) 677 (6V) 392 (4V) 177	(10V) 58.9 (8V) 57.2 (6V) 50.4 (4V) 41	50	8
CA-RM 200 RF ES	16259	220-240	(10V) 160 (8V) 140 (6V) 65 (4V) 24	(10V) 1.20 (8V) 1 (6V) 0.55 (4V) 0.22	(10V) 3250 (8V) 3070 (6V) 2350 (4V) 1615	(10V) 985 (8V) 945 (6V) 720 (4V) 490	(10V) 274 (8V) 263 (6V) 200 (4V) 136	(10V) 106 (8V) 71 (6V) 40 (4V) 19	(10V) 1040 (8V) 696 (6V) 392 (4V) 186	(10V) 53 (8V) 51.8 (6V) 46.3 (4V) 36.8	50	7.9

** Sound pressure measured 3 m in free field in accordance with ISO 9614.

*** Maximum ambient temperature of continuous operation of the product.

Technical data

ENERGY DATA ACCORDING TO REGULATION NO. 1253/2014 / EU

	UNIT OF MEASUREMENT	CA-RM 100 ES	CA-RM 125 ES	CA-RM 150 ES	CA-RM 160 ES	CA-RM 200 ES
CODE		16277	16278	16279	16280	16281
Manufacturer's name or trade name	-	VORTICE	VORTICE	VORTICE	VORTICE	VORTICE
Declared type of ventilation unit	-	UVNR-U**	UVNR-U**	UVNR-U**	UVNR-U**	UVNR-U**
Drive type	-	VSD*	VSD*	VSD*	VSD*	VSD*
Type of HRS heat exchanger	-	none	none	none	none	none
Thermal efficiency of heat recovery	%	NA*	NA*	NA*	NA*	NA*
Nominal flow	m ³ /s	0,090	0,139	0,256	0,296	0,308
Effective electrical power consumption	kW	0,083	0,085	0,160	0,159	0,165
SFPint ****	W/(m ³ /s)	635,49	413,63	343,60	NA*	NA*
Front speed at nominal flow	m/s	11,49	11,385	14,493	14,755	9,813
Nominal external pressure (Δp_s , ext)	Pa	118	85	135	120	81
Internal pressure drop of the ventilation components (Δp_s , int)	Pa	264	180	165	76	86
Internal pressure drop of components unrelated to ventilation (Δp_s , add)	Pa	0	0	0	0	0
Static efficiency of the fans used according to Regulation 327/2011 / EU	%	41.6.	43.5	47.9	36.6	31.2
Maximum percentage of internal case leakage	%	NA*	NA*	NA*	NA*	NA*
Maximum percentage of external case leakage	%	NA*	NA*	NA*	NA*	NA*
Energy performance or energy classification of filters	-	NA*	NA*	NA*	NA*	NA*
Description of the visual signal for filters	-	NA*	NA*	NA*	NA*	NA*
LWA sound power on the speaker	dB(A)	NA*	NA*	NA*	NA*	NA*

* NA: Not applicable.

** UVNR-U: Non-Residential Ventilation Unit - Unidirectional.

*** VM: Multiple speeds. VSD: Variable Speed Drive.

**** SFPint: Internal specific power of the ventilation components.

VSD: with speed variator



Technical data

ENERGY DATA ACCORDING TO REGULATION NO. 1253/2014 / EU

	UNIT OF MEASUREMENT	CA-RM 150 RF ES	CA-RM 160 RF ES	CA-RM 200 RF ES
CODE		16257	16258	16259
Manufacturer's name or trade name	-	VORTICE	VORTICE	VORTICE
Declared type of ventilation unit	-	UVNR-U**	UVNR-U**	UVNR-U**
Drive type	-	VSD	VSD	VSD
Type of HRS heat exchanger	-	none	none	none
Thermal efficiency of heat recovery	%	NA*	NA*	NA*
Nominal flow	m ³ /s	0,211	0,231	0,273
Effective electrical power consumption	kW	0,160	0,166	0,159
SFPint ****	W/(m ³ /s)	NA*	NA*	NA*
Front speed at nominal flow	m/s	11,978	11,514	8,691
Nominal external pressure (Δp_s , ext)	Pa	225	119	99
Internal pressure drop of the ventilation components (Δp_s , int)	Pa	158	229	156
Internal pressure drop of components unrelated to ventilation (Δp_s , add)	Pa	0	0	0
Static efficiency of the fans used according to Regulation 327/2011 / EU	%	50,6	48,5	43,8
Maximum percentage of internal case leakage	%	NA*	NA*	NA*
Maximum percentage of external case leakage	%	NA*	NA*	NA*
Energy performance or energy classification of filters	-	NA*	NA*	NA*
Description of the visual signal for filters	-	NA*	NA*	NA*
LWA sound power on the speaker	dB(A)	NA*	NA*	NA*

* NA: Not applicable.

** UVNR-U: Non-Residential Ventilation Unit - Unidirectional.

*** VM: Multiple speeds. VSD: Variable Speed Drive.

**** SFPint: Internal specific power of the ventilation components.

VSD: with speed variator

Dimensions

CA-RM ES

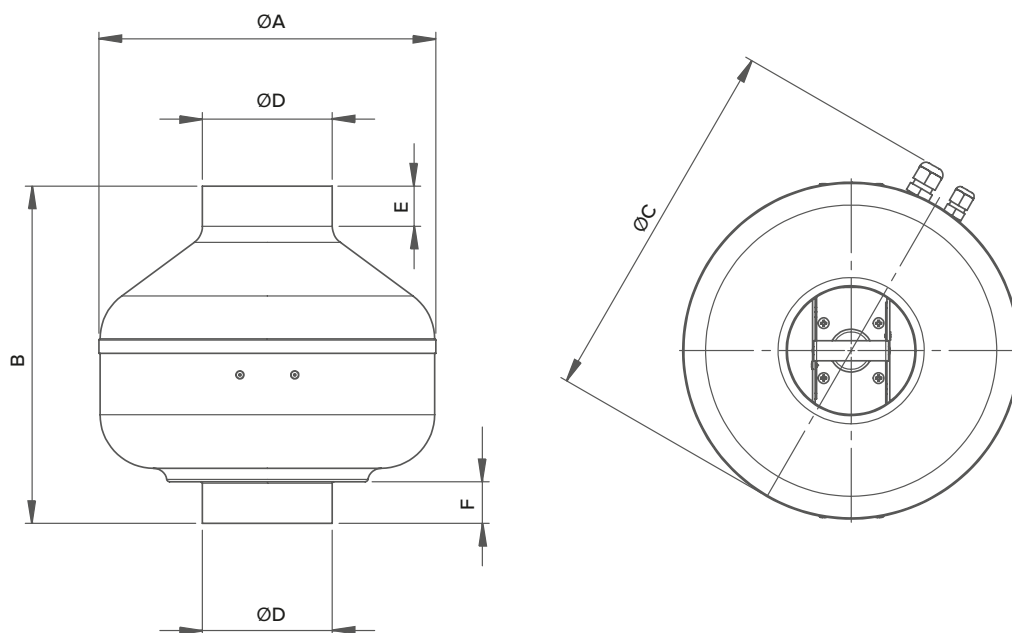

14

PRODUCTS	CODE	$\varnothing A$	B	$\varnothing C$	$\varnothing D$	E	F
CA - RM 100 ES	16277	252	252	276	97	30	31
CA - RM 125 ES	16278	252	252	276	122	30	31
CA - RM 150 ES	16279	342	295	367	147	30	36
CA - RM 160 ES	16280	342	295	367	157	30	36
CA - RM 200 ES	16281	342	337	367	197	40	77

Dimensions in mm



Dimensions

CA-RM RF ES

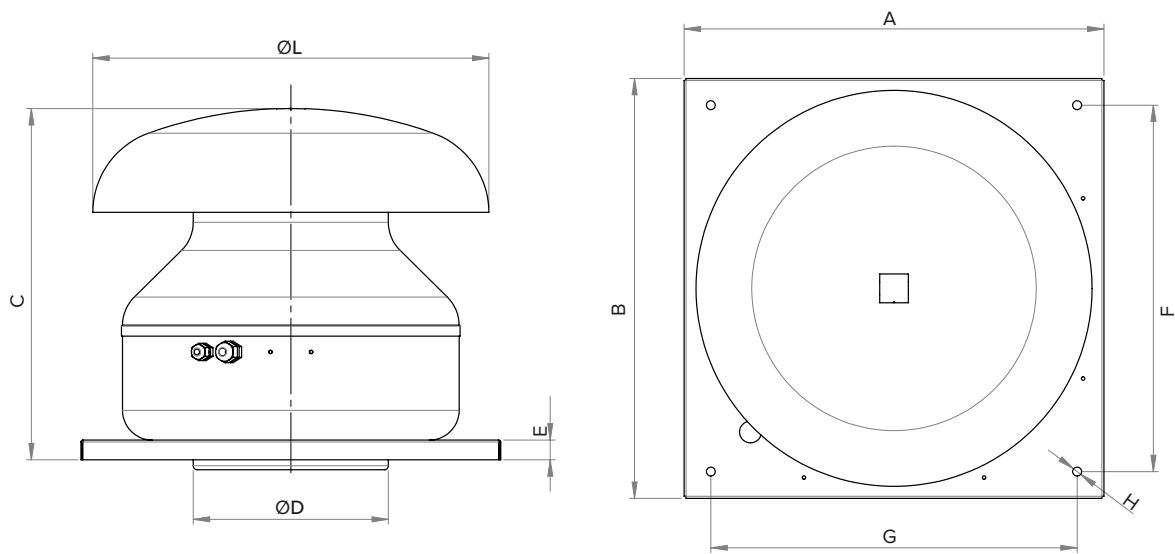

PRODUCTS	CODE	A	B	C	ØD	E	F	G	H	ØL
CA - RM 150 RF ES	16257	424	424	363	147	20	370	370	9	400
CA - RM 160 RF ES	16258	424	424	363	157	20	370	370	9	400
CA - RM 200 RF ES	16259	424	424	355	197	20	370	370	9	400

Dimensions in mm

Curves

CA-RM 100 ES Cod.16277

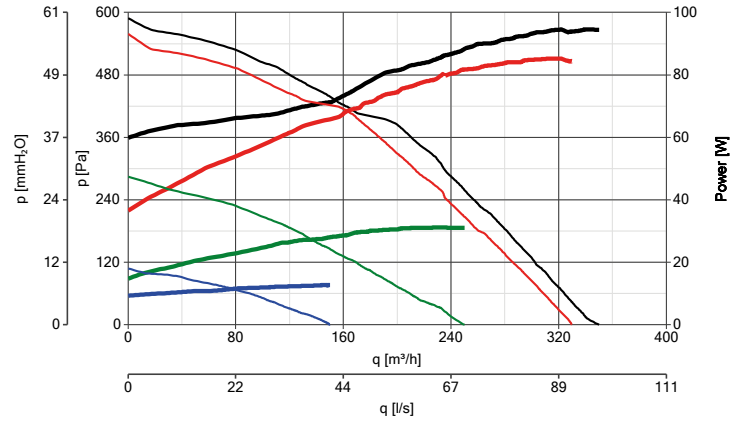

CA-RM 125 ES Cod.16278

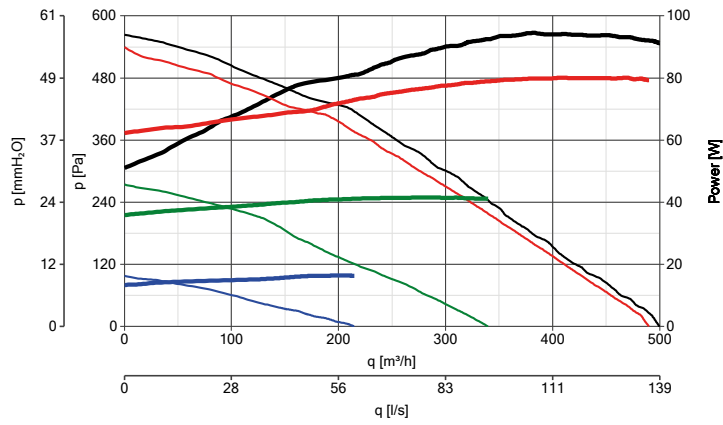

CA-RM 150 ES Cod.16279

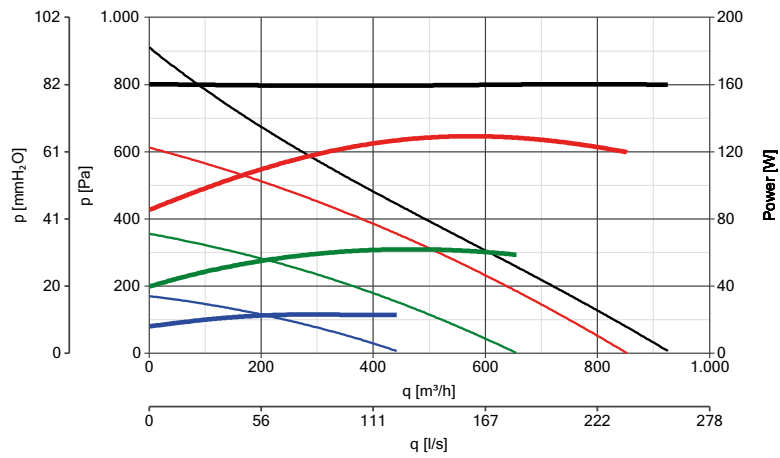



Curves

CA-RM 160 ES Cod.16280

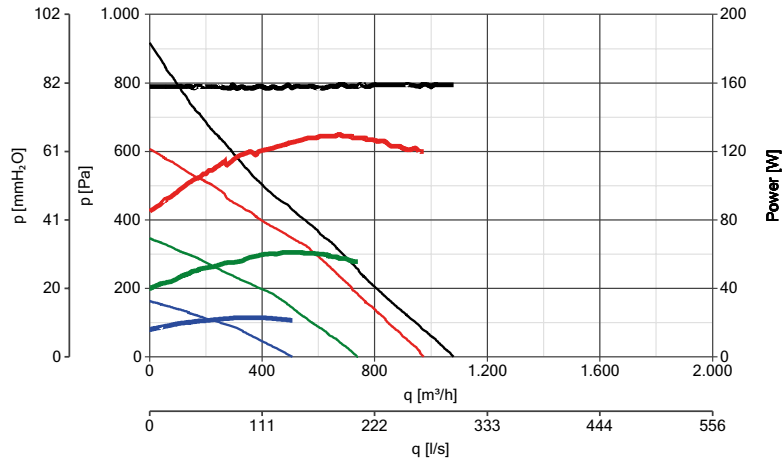

CA-RM 200 ES Cod.16281

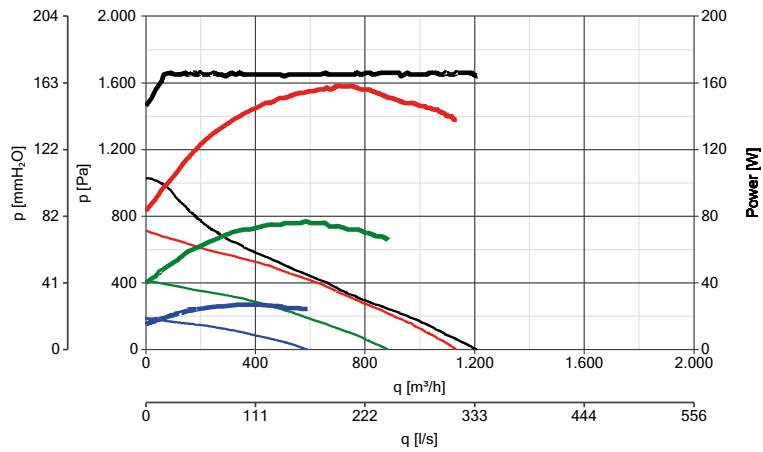

KEY:

- Power (10V regulation)
- Power (8V regulation)
- Power (6V regulation)
- Power (4V regulation)

Curves

CA-RM 150 RF ES Cod.16257

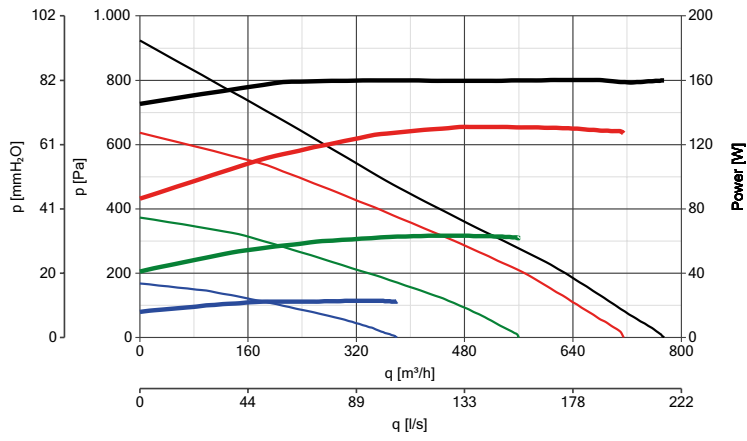

18

CA-RM 160 RF ES Cod.16258

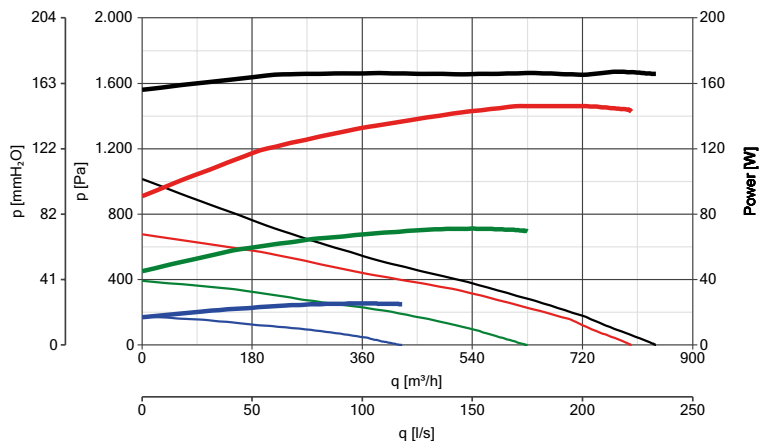





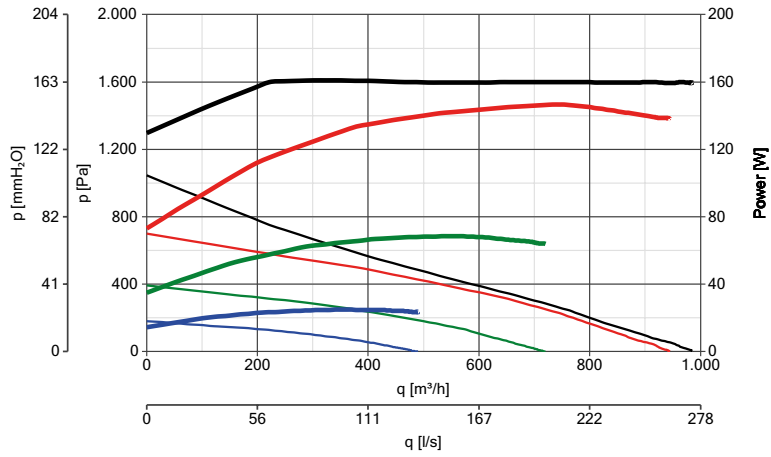

Curves







CA-RM 200 RF ES Cod.16259



KEY:







-  Power (10V regulation)
-  Power (8V regulation)
-  Power (6V regulation)
-  Power (4V regulation)

Accessories

MODELS	DESCRIPTION	CODE	PRODUCTS
KIT FSG 100			
	Kit (2 sleeves) for duct installation CA-RM 100 ES	20210	16277
KIT FSG 125			
	Kit (2 sleeves) for duct installation CA-RM 125 ES	20211	16278
KIT FSG 150			
	Kit (2 sleeves) for duct installation CA-RM 150 ES.	20212	16279
KIT FSG 160			
	Kit (2 sleeves) for duct installation CA-RM 160 ES.	20213	16280
KIT FSG 200			
	Kit (2 sleeves) for duct installation CA-RM 200 ES. .	20214	16281
KIT FSG-FLS 100			
	Kit consisting of flow switch, for monitoring the extracted flow and 2 sleeves for the series connection of two units with nominal diameter of 100 mm.	20215	16277
KIT FSG-FLS 125			
	Kit consisting of a flow switch, for monitoring the extracted flow and 2 sleeves for the series connection of two units with a nominal diameter of 125 mm.	20216	16278



Accessories

MODELS	DESCRIPTION	CODE	PRODUCTS
KIT FSG-FLS 150 	Kit consisting of flow switch, for monitoring the extracted flow and 2 sleeves for the series connection of two units with a nominal diameter of 150 mm.	20217	16279 16257
KIT FSG-FLS 160 	Kit consisting of flow switch, for monitoring the extracted flow and 2 sleeves for the series connection of two units with a nominal diameter of 150 mm.	20218	16280 16258
KIT FSG-FLS 200 	Kit consisting of flow switch, for monitoring the extracted flow and 2 sleeves for the series connection of two units with a nominal diameter of 200 mm.	20219	16281 16259
KIT PZT-SU 55x55 Ø 100 - 125 	Driveway in plastic material	20223	16277 16278
KIT PZT-SU 55x55 Ø 150 - 160 - 200 	Driveway in plastic material	20224	16279 16280 16281
KIT RF 150 	Accessories for installation in duct models at the end of a short vertical pipe.	20375	16279
KIT RF 160 	Accessories for installation in duct models at the end of a short vertical pipe.	20376	16280
KIT RF 200 	Accessories for installation in duct models at the end of a short vertical pipe.	20377	16281

REGULATORS

SICURBOX



Control unit for the management and monitoring of the system. The device allows independent regulation of up to 2 fans, verification of their correct operation and reporting of any malfunctions.

20204

16277
16278
16279
16280
16281
16257
16258
16259

POT-IT



Potentiometer for adjusting the fan speed, compatible with wall and recessed installation in UNI503 standard box.

12826

16277
16278
16279
16280
16281
16257
16258
16259

POT



Potentiometer for adjusting the fan speed, compatible with wall and recessed installation in a standard DIN box.

12828

16277
16278
16279
16280
16281
16257
16258
16259



THE SERIES



CA-RM ES



CA-RM RF ES

WIRING PLATE



SICURBOX CONTROL UNIT



Device that manages and monitors ventilation system for RADON mitigation. It allows the regulation of the associated fans, the monitoring of their correct functioning, the signaling of any faults and the programming of the most appropriate operating logics.

EXAMPLE OF DUCT INSTALLATION

RADON GAS REMEDIATION (WORK)



Preparation of extraction point

CA-RM 160ES installation
in line with the duct



SICURBOX control unit installation
for control, monitoring and
management.





EXAMPLE OF ROOF INSTALLATION

Terminal section of the exhaust duct



CA RM 200 RF ES installation

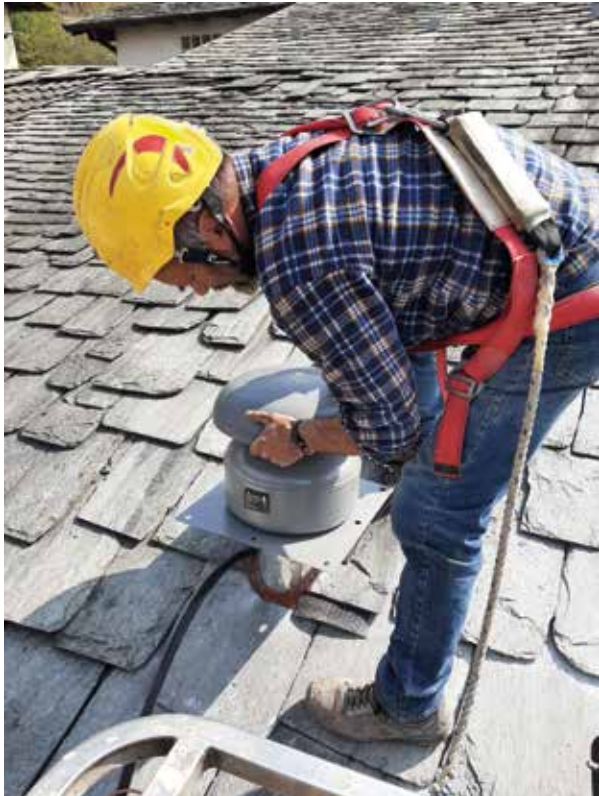

VORTICE GROUP COMPANIES

VORTICE S.P.A

Strada Cerca, 2
District of Zoate
20067 Tribiano
(Milan) Italy
Tel. (+39) 02 906991
Fax (+39) 02 90699625
vortice.com

VORTICE LIMITED

Beeches House
Eastern Avenue
Burton upon Trent
DE13 0BB United Kingdom
Tel. (+44) 1283-49.29.49
Fax (+44) 1283-54.41.21
vortice.ltd.uk

VORTICE INDUSTRIAL S.R.L.

Via B. Brugnoli 3,
37063 Isola della Scala
(Verona) Italy
Tel. (+39) 045 6631042
Fax (+39) 045 6631039
vorticeindustrial.com

CASALS VENTILACIÓN AIR INDUSTRIAL S.L.

Ctra. Camprodon, s/n 17860
Sant Joan de les Abadesses
(Girona) Spain
Tel. (+34) 972720150
casals.com

VORTICE LATAM S.A.

Bodega #6
Zona Franca Este Alajuela,
Alajuela 20101
Costa Rica
Tel. (+506) 2201.6934
vortice-latam.com

VORTICE VENTILATION SYSTEM

(Changzhou) Co.LTD
No. 388 West Huanghe Road
Building 19, Changzhou
Post Code: 213000 China
Tel. (+86) 0519 88990150
Fax (+86) 0519 88990151
vortice-china.com

TOLL-FREE NUMBER

800 555 777

The descriptions and illustrations in this catalogue are intended to be indicative and not binding. Without prejudice to the essential characteristics of the products described and illustrated here, VORTICE reserves the right to make, at any time and without notice, any changes to parts, aesthetic details or supply of accessories to its products that are deemed to be appropriate for improvement or for any construction or commercial requirement. This printout completely cancels and replaces all previous ones.

