

Abmessungen / Dimensions / Dimensioni

ELM 22

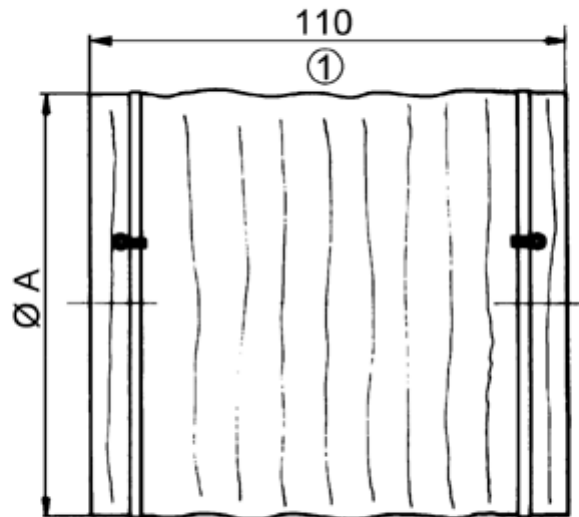

$$A = 225$$

Masse / Dimensions / Dimensioni, mm