

Abmessungen / Dimensions / Dimensioni

ER/DR 400

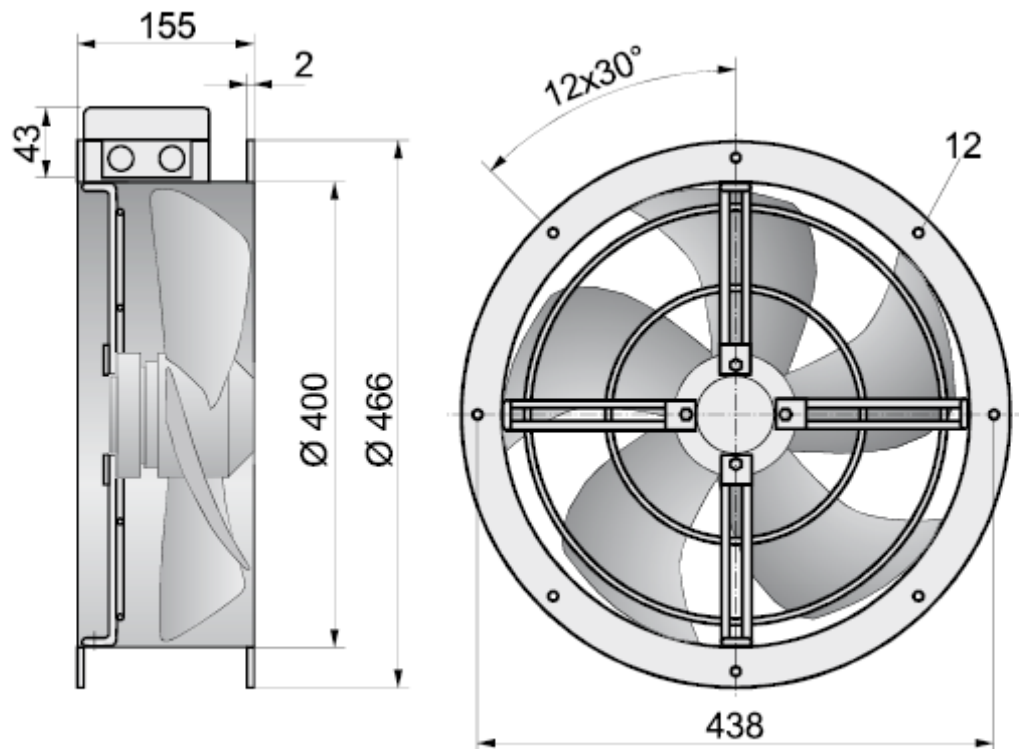

Masse / Dimensions / Dimensioni, mm