

**Abmessungen / Dimensions / Dimensioni**

**ER/DR 630**

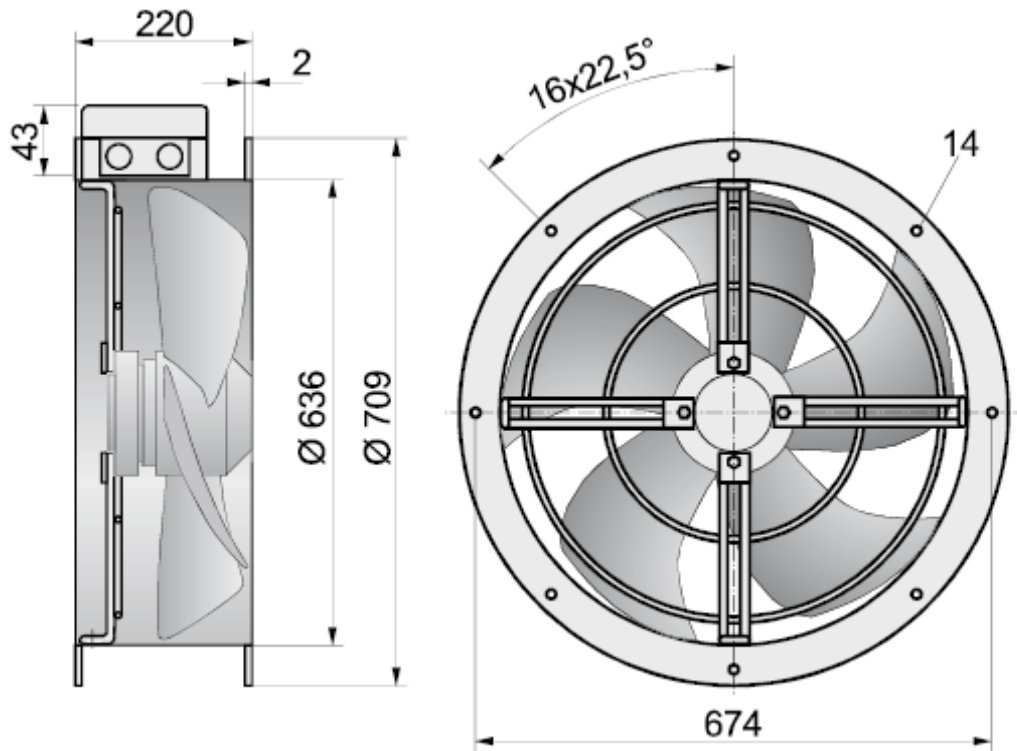

Masse / Dimensions / Dimensioni, mm