

Abmessungen / Dimensions / Dimensioni

C-Series ATEX

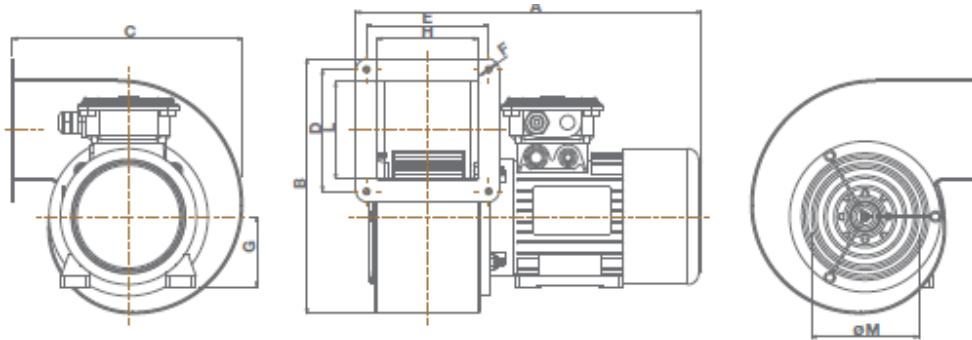

Models	A	B	C	D	E	F	G	H	L	Ø M	Kg	
C 10/2 T ATEX	260	186	171	72	82	6.5	56	68	63	80	4	
C 15/2 T ATEX	280	234	206	108	100	7	56	83	88	108	4.5	
C 20/2 T ATEX	350	258	232	123	123	8.50	71	102	98	108	8.5	
C 25/2 T ATEX	365			124	142			115			8.5	
C 30/2 T ATEX	365	308	272	126	137			117	108	132	10	
C 30/4 T ATEX											7.5	
C 31/4 T ATEX	365	400	340	164	139			112	137	170	10.5	
C 35/4 T ATEX	400				174						11.5	
C 37/4T ATEX	425	471	416.50	220	182			80	149	187	199	17

Masse / Dimensions / Dimensioni, mm

TECHNICAL DATA

Models	Code	W	A	POLES	RPM	Max Airflow		Max Pressure		Lp dB(A) a 3 m*	Max °C
						m³/h	l/s	mmH ₂ O	Pa		
C 10/2 T ATEX	30301	120	0.36	2	2800	280	77.8	26	255	55.5	40
C 15/2 T ATEX	30304	175	0.39			430	119.4	44	430	59	
C 20/2 T ATEX	30305	472	1.09			1000	277.8	56	549	66	
C 25/2 T ATEX	30306	482	1.10			1100	305.6	67	657	66.5	
C 30/2 T ATEX	30307	902	1.57			1350	375	83	814	71	
C 30/4 T ATEX	30308	226	0.95	4	1400	700	194.4	18	177	55	
C 31/4 T ATEX	30309	375	1.01			1120	311.1	31	304	61	
C 35/4 T ATEX	30310	401	1.02			1500	416.7	34	334	61	
C 37/4 T ATEX	30311	803	1.80			2150	597.2	48	470	70	

* Sound pressure level measured at 3 m in free field conditions with long-cased appliance in delivery mode, in accordance with standard EN ISO 3741:2009.

PERFORMANCE CURVES

C 10/2 T ATEX code 30301

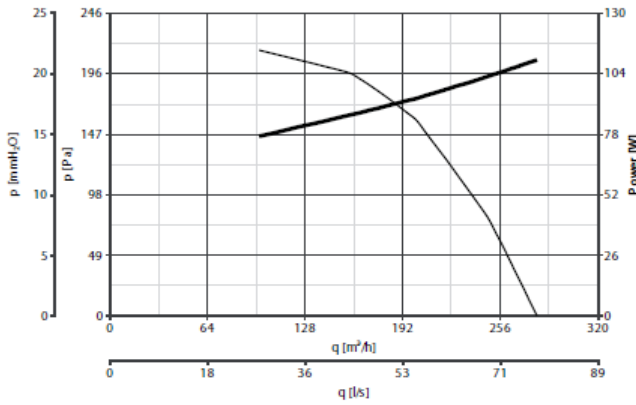

C 15/2 T ATEX code 30304

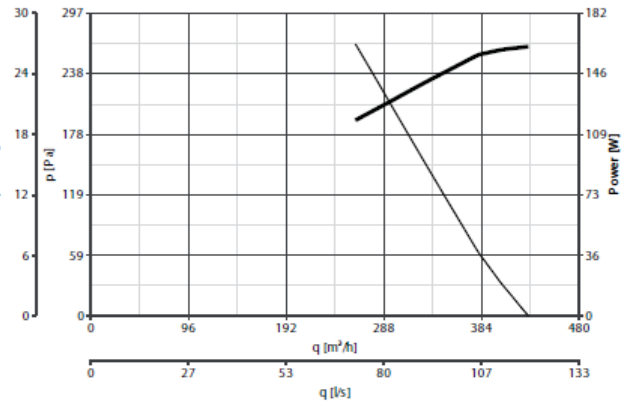

C 20/2 T ATEX code 30305

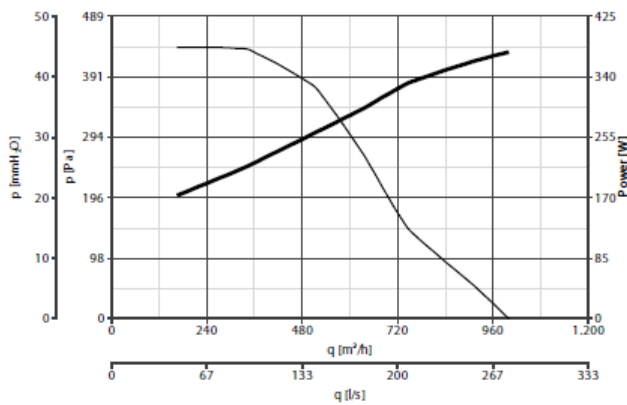

C 25/2 T ATEX code 30306

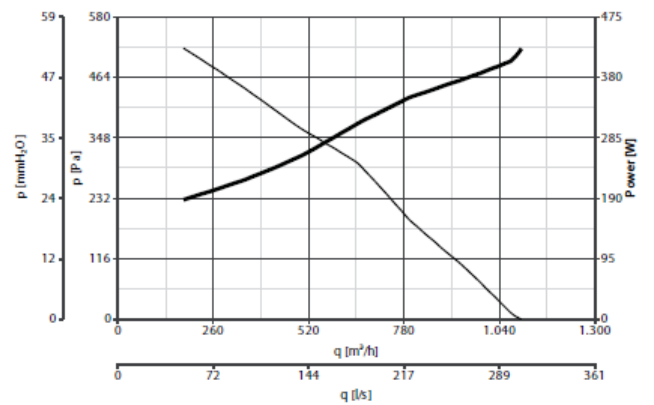

C 30/2 T ATEX code 30307

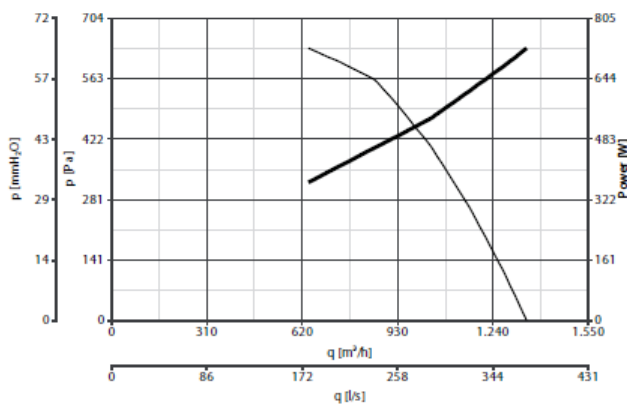

C 30/4 T ATEX code 30308

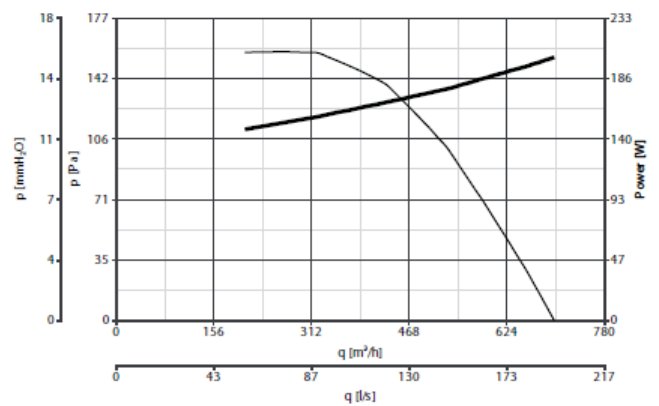

C 31/4 T ATEX code 30309

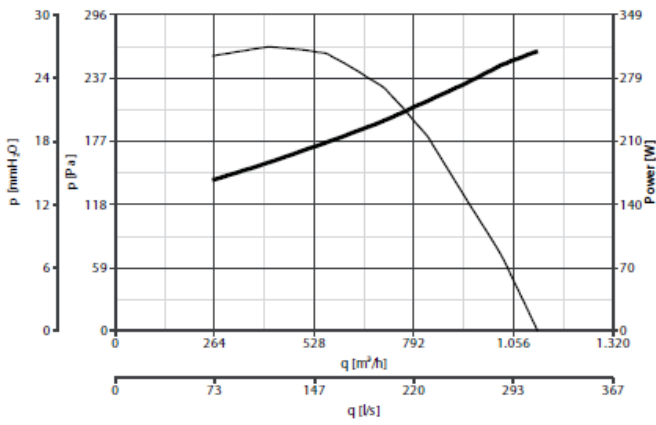

C 35/4 T ATEX code 30310

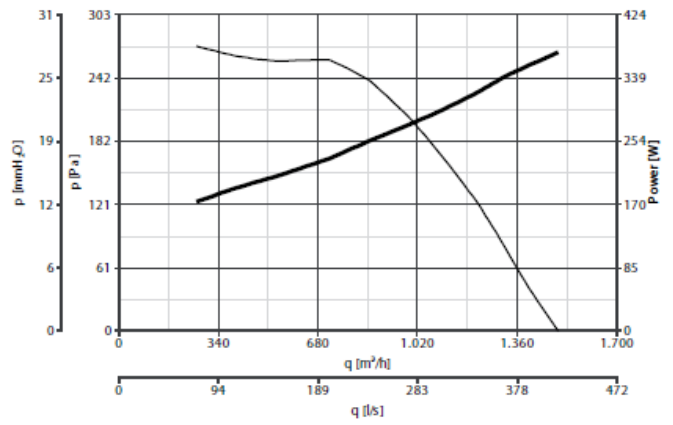

C 37/4 T ATEX code 30311

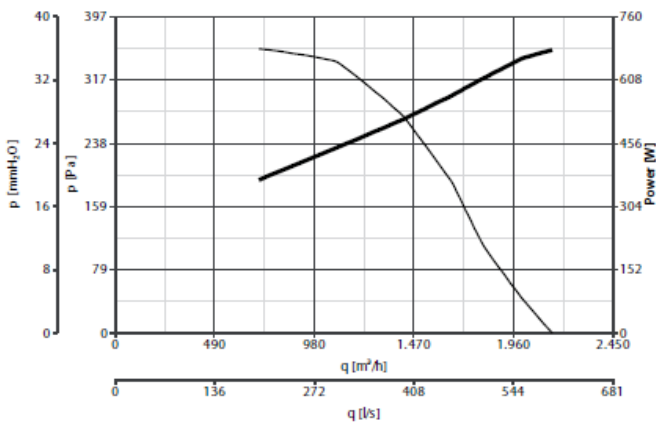

— Delivery — Consumption