

**Abmessungen / Dimensions / Dimensioni**

**DVA 250 E4 30**

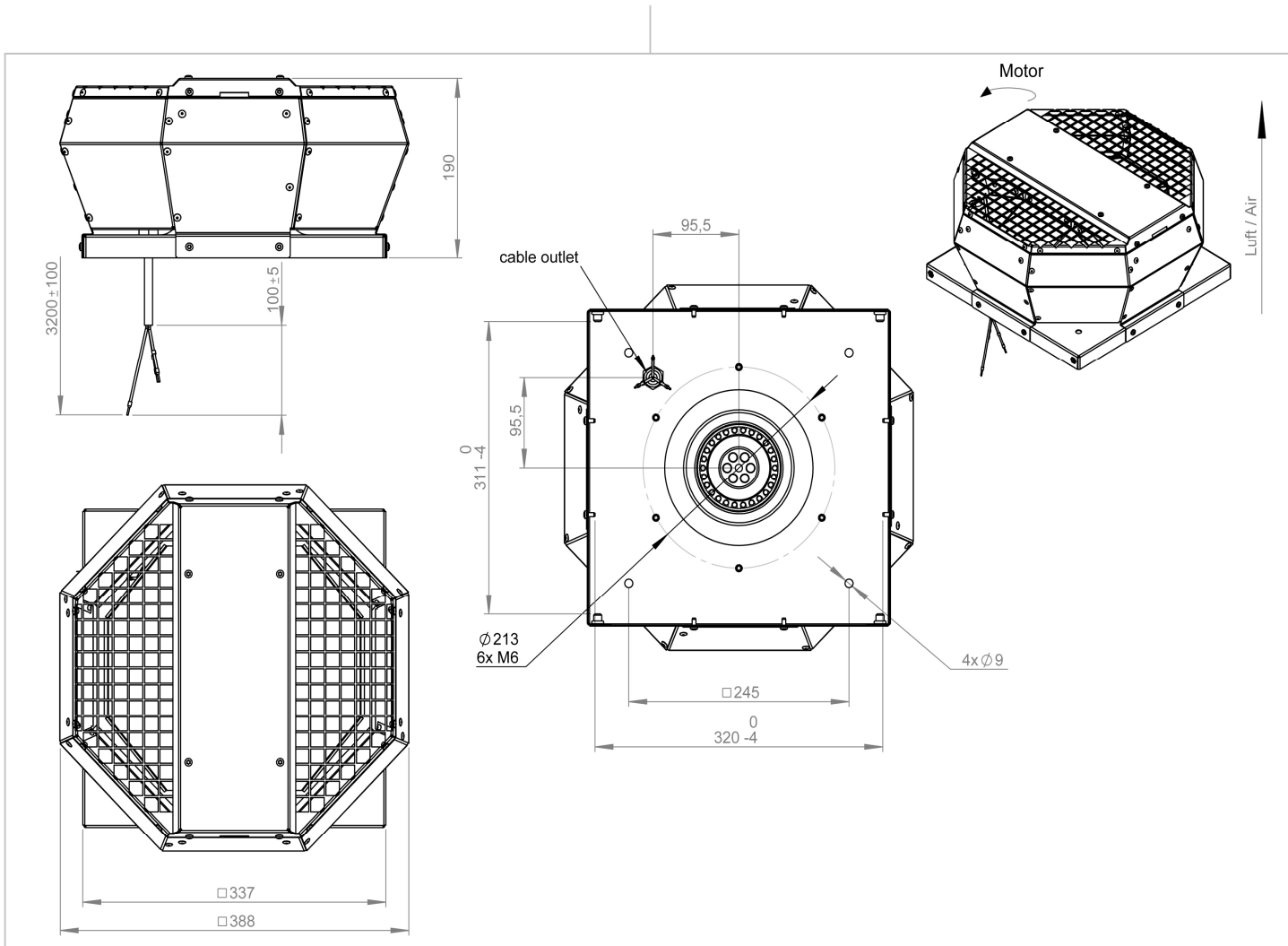

**Masse / Dimensions / Dimensioni, mm**