

Abmessungen / Dimensions / Dimensioni

Rohrrückschlagklappe zu Lineo 315 VO.

Masse / Dimensions / Dimensioni, mm

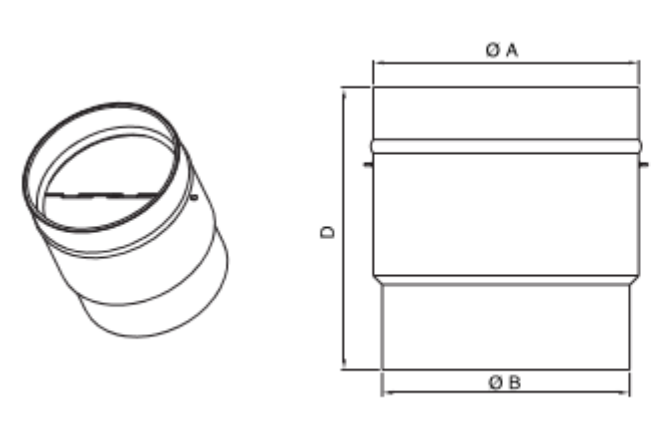

Ø Nom.	Cod.	Ø A	Ø B	D
100	22551	103	96	100
125	22556	128	122	110
150	22562	153	146	120
160	22563	163	156	125
200	22566	203	196	150
250	22571	253	247	180
315	22576	318	312	210
355	22552	358	352	250
400	22553	403	397	285