

Abmessungen / Dimensions / Dimensioni

Lüftungsgerät VN 308

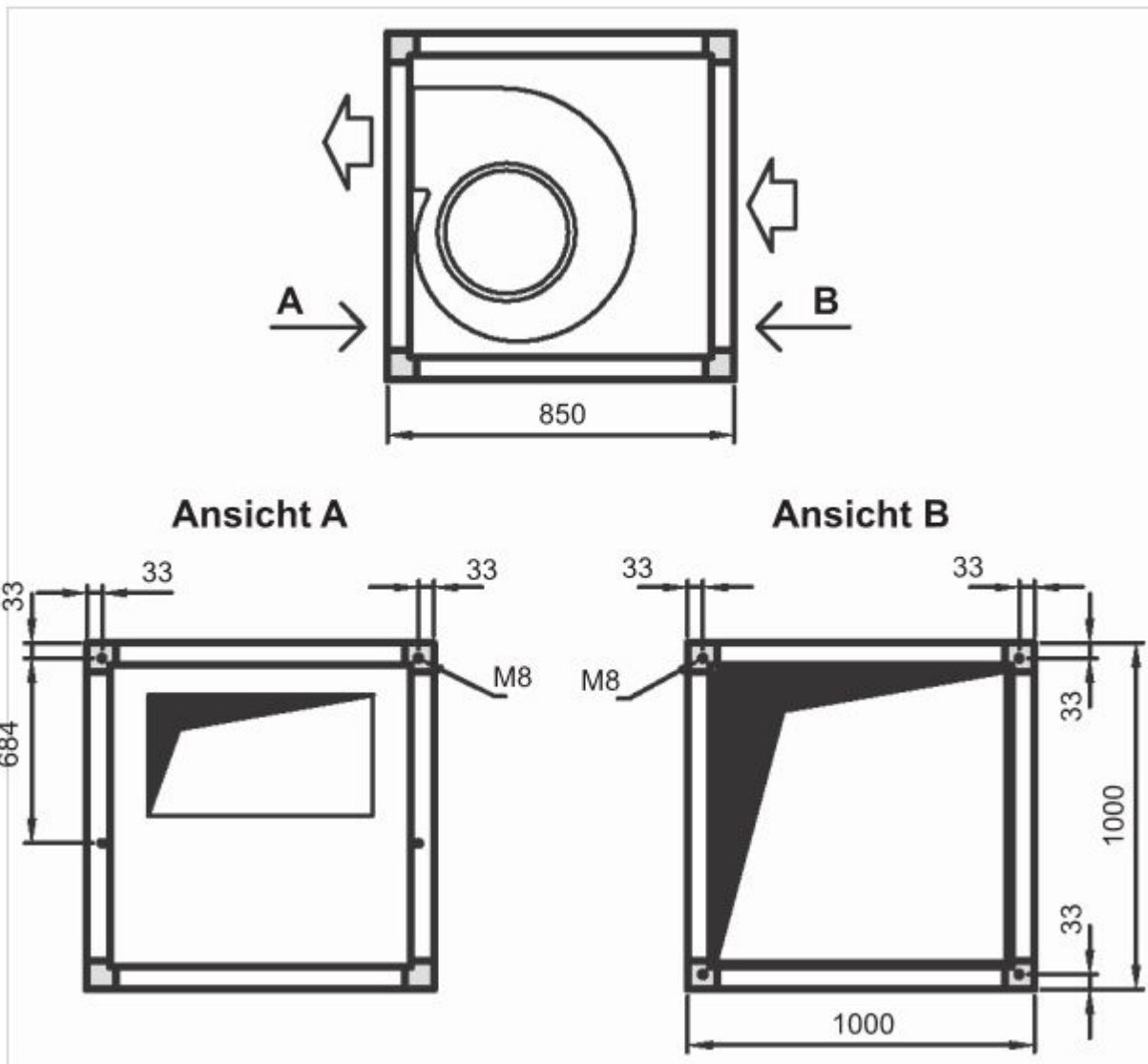

Masse / Dimensions / Dimensioni, mm