

Anschlussschema / Schéma de raccordement / Schema di allacciamento

FLRE 630/D2

Anschlußplan
0.13-2 r.

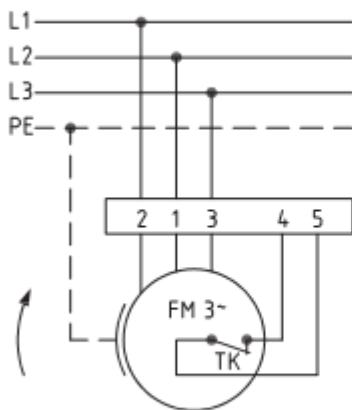

rechtsdrehend

Anschlußplan
0.13-2 l.

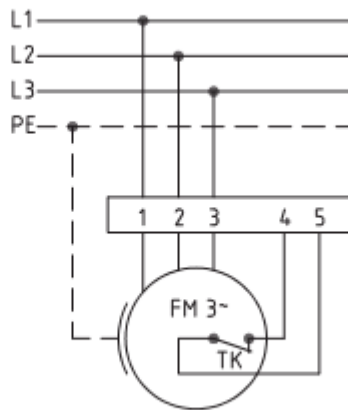

linksdrehend



Der Leiseläufer