

Abmessungen / Dimensions / Dimensioni

FUM 22

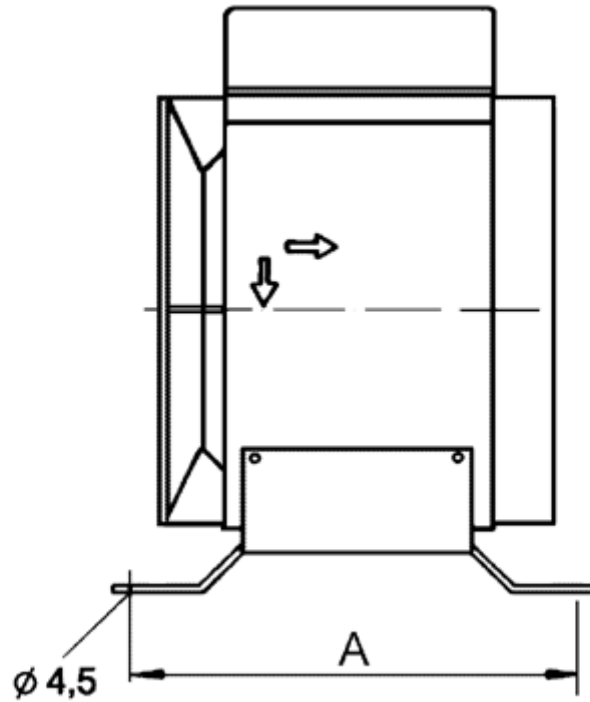

$$A = 203$$

Masse / Dimensions / Dimensioni, mm